



PORTIO JET

Intelligent
Waterjet Cutter



Introduction

When MARELEC launched its first PORTIO back in 2008, it answered a growing demand in the food-processing market. The machine was first introduced for fish processing, but soon after, the three-camera version was developed for the meat industry. This was the start of a successful product line that quickly developed into dedicated versions that would soon be used worldwide in all segments of the fish, meat and poultry processing industries.

In 2023, Duravant, a worldwide supplier of custom equipment and automation solutions for the food processing, packaging and material handling industries, acquired MARELEC Food Technologies. Leveraging its expertise in engineering, integration, project management and operational excellence, Duravant delivers comprehensive process solutions to customers and collaborators through its extensive global sales, distribution and service networks. Duravant's market-leading trademarks are known for their innovation, durability and reliability, aligning seamlessly with MARELEC's values.

Today, we are proud to present a complete range of intelligent portion cutters including the waterjet. All models have been created with a customer-centric focus and are built using the extensive expertise we have gained in food processing since the early nineties.

We kindly invite you to browse through our brochure to find out more about the different PORTIO JET models, applications and our unique selling points. Our sales team is ready to answer any questions you may have.

Regardless of which PORTIO you need, choosing MARELEC - a worldwide leader in this technology - will ensure that you are working with a service-oriented company, one that listens to your specific needs and is a flexible partner with a human approach. We look forward to a mutually profitable cooperation!

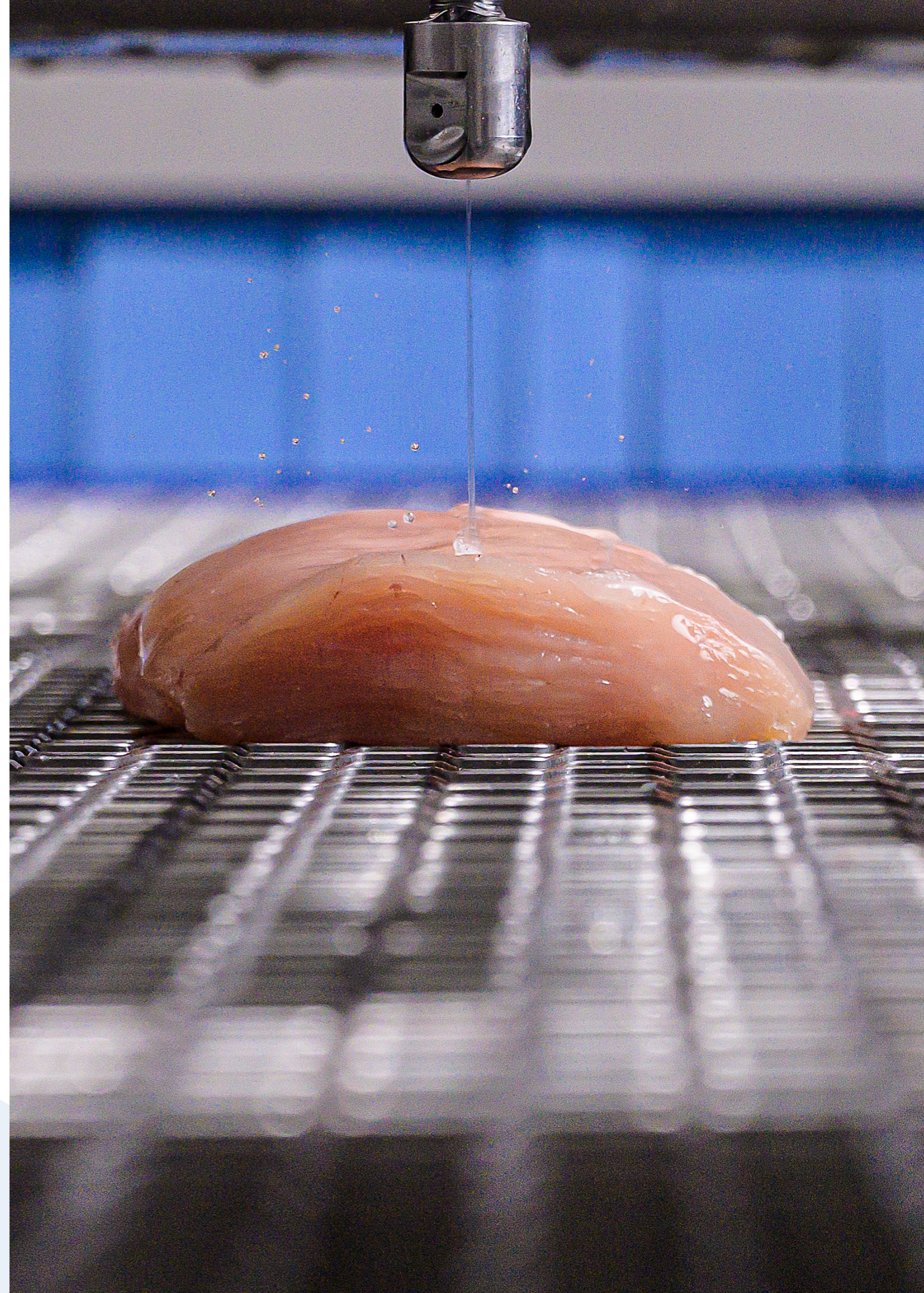

Unique Selling Points

1 // OPTIMIZED YIELD

Combining MARELEC's proven vision technology with the PORTIO JET optimization software and state-of-the-art nozzles results in the highest possible yields.

2 // FLEXIBLE CUTTING ALGORITHMS

The PORTIO JET optimization software calculates which cuts have priority over others to determine the cutting pattern that results in most value.

3 // UNPARALLELED ACCURACY

The waterjet cutter PORTIO JET uses the latest well-known and proven vision technology. A 200Hz camera scans the chicken fillets or boneless leg meat and converts this into an exact copy in a 3D model.

4 // MODULAR DESIGN FOR INCREASED CAPACITY

The base unit of our waterjet cutter consists of one scanning station and a module with two high-pressure cutting stations. This is called the PORTIO JET 2. Depending on customer needs, the PORTIO JET 2 can be extended with three additional modules, each with two high-pressure waterjet stations, resulting in eight cutting stations in total.

5 // USER-FRIENDLY SOFTWARE INTERFACE

Intuitive programming of cutting patterns and fast and easy fine-tuning of the programs results in maximum yields. The cutting pattern is shown on the screen along with an indication of the thickness and the weight of every portion.

6 // EXTREMELY HYGIENIC, EASY TO CLEAN

The waterjet cutter complies with the most stringent hygiene standards. The open structure of the portioning machine for poultry allows for the pressure washing and disinfecting of all interior and exterior surfaces. All cabinets with electrics and electronics have a unique drying system to prevent condensation building up, plus our dual-sealing concept on all doors.

7 // SERVICE

MARELEC has built a very strong reputation for its after sales service. Our team of service engineers is available 24/7 to reply to your queries. All machines can be connected to the internet, which allows our service team to diagnose the status of the machine from our head office. This enables us to provide you with on-the-spot assistance.



PORTIO JET

The PORTIO JET was designed to maximize yields while cutting poultry fillets or deboned leg meat. The payback of this machine is proven when shape and weight are of high importance for the customer. Cutting in two dimensions offers greater flexibility, resulting in a larger yield than cutting with a 1D machine.

There is a list of established cutting patterns that can be altered using criteria such as weight, size, and shape. There is also a mode in which product-cutting patterns can be generated directly on the touch-screen to define requirements. Specific end-customer recipes can be saved into the machine under a customized name, allowing you to switch cutting patterns in seconds. The machine can process multiple streams of products next to each other on the 660mm/26inch wide belt, and work with multiple applications simultaneously.

Typical applications include cutting chicken fillets into fixed-weight portions, cubes or strips. Boneless leg meat can be trimmed down and portioned into fixed-weight portions, better known as steaks or thigh patty. Very popular patterns are strips or cubes, such as karaage, kakugiri or BLK.

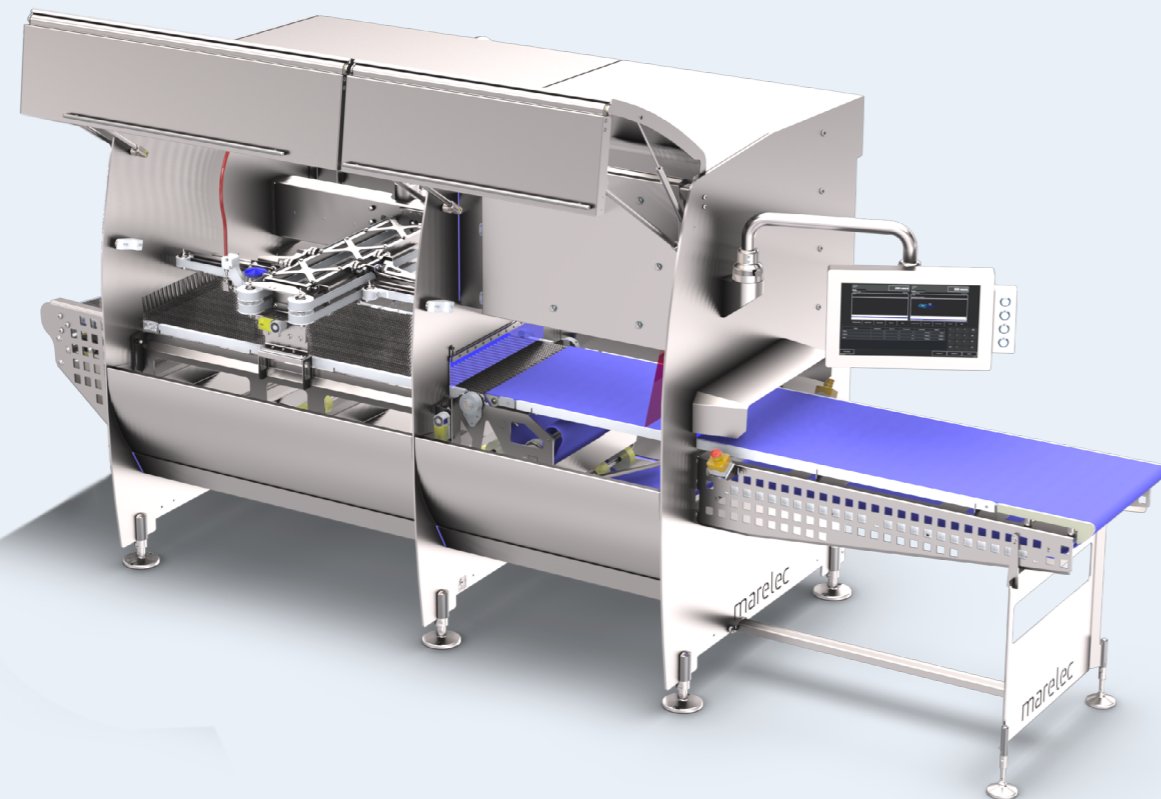

The PORTIO JET is built in a modular way. It starts with the base module, in which all electronics, scanning and HMI are integrated. As standard, this base unit controls a module with two cutting stations. This combination is called PORTIO JET 2.

The standard unit can be extended into a series of modules, each with two high-pressure waterjet nozzles - up to four modules or eight stations in total. Thanks to the modular design, these extra stations can be added whenever your volumes require it.

The MATRIX J software collects all production data from the PORTIO JET, enabling it to generate production reports per shift or program and to trace changes at a machine level. MATRIX J software enables users to remotely create programs offline and monitor the machine status through an event log.



Overview

Applications & capacities

Product	Raw material	Application	PORTIO JET 2	PORTIO JET 4	PORTIO JET 6	PORTIO JET 8
			Capacity			
	Fillets ≈ 250g/8,8oz	Cubes 15g/0,5oz	> 500 kg/1102 lb per hour	> 1000 kg/2204 lb per hour	> 1500 kg/3306 lb per hour	> 2000 kg/4409 lb per hour
		Cubes 30g/1,1oz	> 1000 kg/2204 lb per hour	> 2000 kg/4409 lb per hour	> 3000 kg/6613 lb per hour	> 4000 kg/8818 lb per hour
		Strips 45g/1,6oz	> 1500 kg/3306 lb per hour	> 3000 kg/6613 lb per hour	> 4500 kg/9920 lb per hour	> 6000 kg/13227 lb per hour
	≈ 120g/4,2oz deboned thigh meat*	Thigh patty / steak 85g/3oz	> 1000 kg/2204 lb per hour	> 2000 kg/4409 lb per hour	> 3000 kg/6613 lb per hour	> 4000 kg/8818 lb per hour
	≈ 220g/7,8oz deboned whole leg meat*	Cubes / BLK 20g/0,7oz	> 700 kg/1543 lb per hour	> 1400 kg/3086 lb per hour	> 2100 kg/4629 lb per hour	> 2800 kg/6172 lb per hour

* With optional 6000 bar pump
Specifications depend on product characteristics. Contact our sales team to find out the yield and capacity for your application.

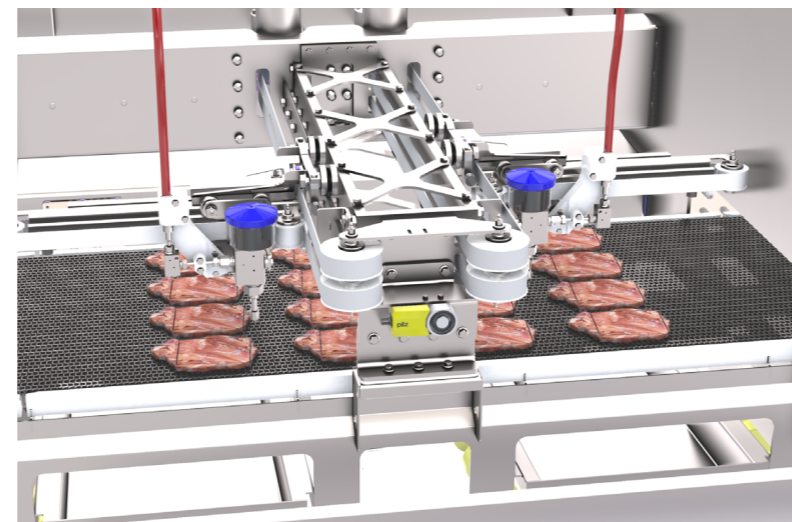
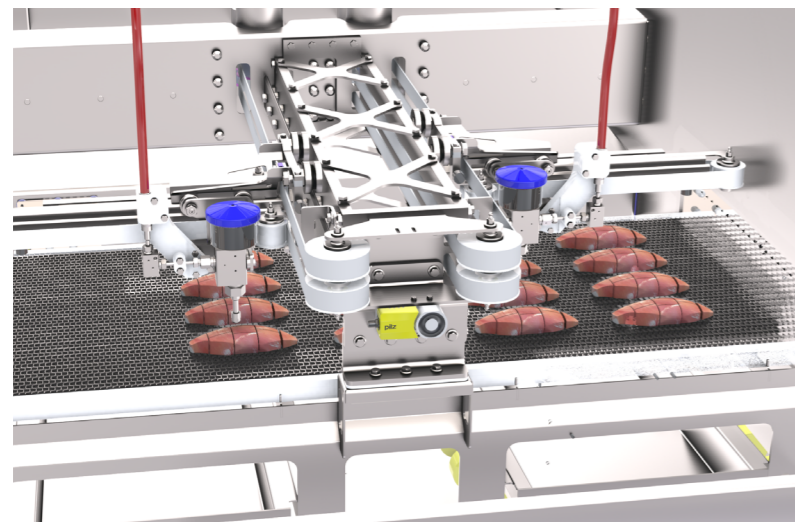

Scan to see the machine in action

Cutting patterns

Half-breast Portions

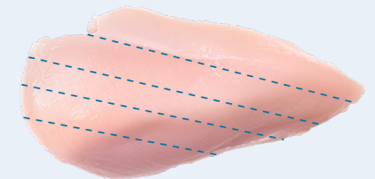
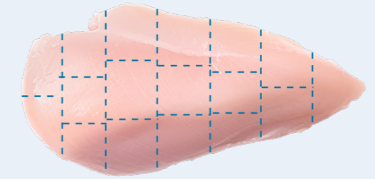
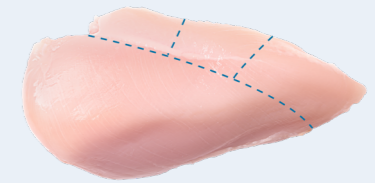

Leg Meat

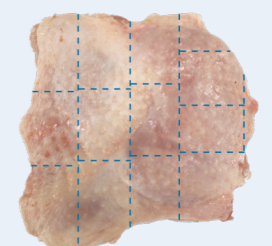
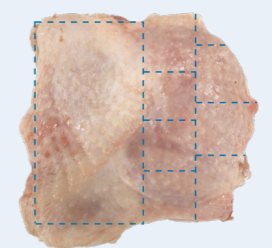
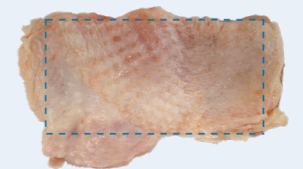

Specifications

	PORTIO JET 2	PORTIO JET 4	PORTIO JET 6	PORTIO JET 8
L x W x H	4550 x 1657 x 2031 mm / 179 x 65 x 80 inch	6000 x 1657 x 2031 mm / 236 x 65 x 80 inch	7450 x 1657 x 2031 mm / 293 x 65 x 80 inch	8900 x 1657 x 2031 mm / 350 x 65 x 80 inch
Net weight	1500 kg/ 3306 lb	2000 kg/ 4409 lb	2500 kg/ 5511 lb	3000 kg/ 6613 lb
Belt width	660 mm / 26 inch			
Cutting stations	2	4	6	8
Belt speed	50 - 450 mm/s			
Power plug of the pump	3 x 400 VAC + N + PE 80A	3 x 400 VAC + N + PE 80A	3 x 400 VAC + N + PE 80A	3 x 400 VAC + N + PE 80A
Power plug of the machine	3 x 400 VAC + N + PE + 32A			
Total Power*	40 kW	42 kW	44 kW	46 kW
Water consumption*	200 liters/53 gallons per hour	400 liters/106 gallons per hour	600 liters/158 gallons per hour	800 liters/211 gallons per hour
Maximum pressure	standard: 3800 bar optional: 6000 bar***			

* Depends on diameter of chosen nozzles. Contact our sales team to verify the power and water consumption for your application.

** Available programs can be expanded upon request.

*** More power at higher pressure is required.

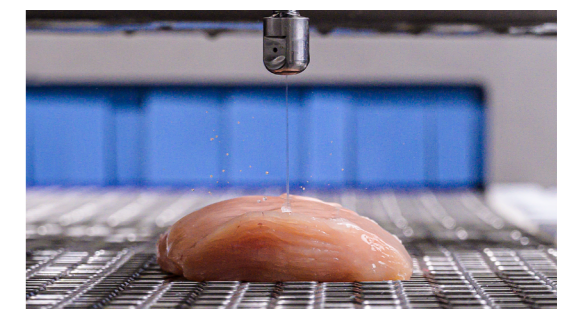
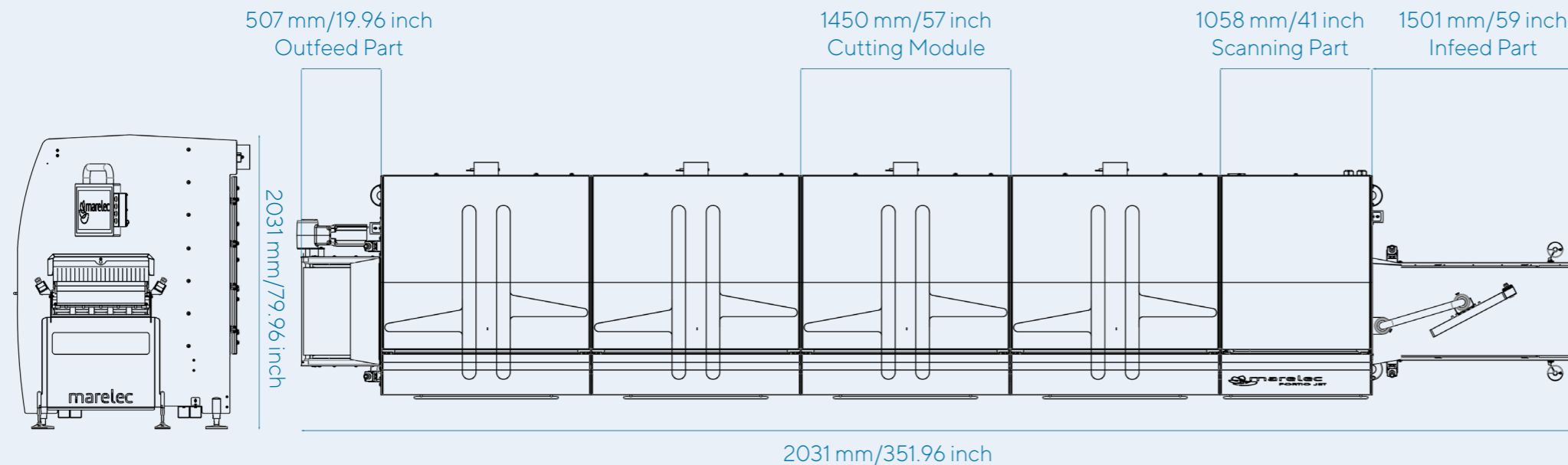



MARELEC Food Technologies

Redanweg 15 - 8620 Nieuwpoort - Belgium - T +32 58 222 111 - sales@marelec.com



MARELEC IS A MEMBER OF THE **DURAVANT** FAMILY OF COMPANIES

PACKAGING SOLUTIONS | FOOD PROCESSING SOLUTIONS | MATERIAL HANDLING SOLUTIONS

www.duravant.com